

P/N: 63901-0101

Copyright

© 2015, FLIR Systems, Inc.

All rights reserved worldwide. Names and marks appearing herein are either registered trademarks or trademarks of FLIR Systems and/or its subsidiaries. All other trademarks, trade names or company names referenced herein are used for identification only and are the property of their respective owners.

Document identity

Publ. No.: 63901-0101

Release:

Commit: 30746

Language: en-US

Modified: 2015-11-24

Formatted: 2015-11-24

Website

<http://www.flir.com>

Customer support

<http://support.flir.com>

Disclaimer

Specifications subject to change without further notice. Camera models and accessories subject to regional market considerations. License procedures may apply. Products described herein may be subject to US Export Regulations. Please refer to exportquestions@flir.com with any questions.



General description	
<p>The FLIR Ex series cameras are point-and-shoot infrared cameras that give you access to the infrared world. A FLIR Ex series camera is an affordable replacement for an infrared thermometer, providing a thermal image with temperature information in every pixel. The new MSX and visual formats make the cameras incomparably easy to use.</p> <p>The FLIR Ex series cameras are user-friendly, compact, and rugged, for use in harsh environments. The wide field of view makes them the perfect choice for building applications.</p>	
Benefits:	
<ul style="list-style-type: none"> • Easy to use: The FLIR Ex series cameras are fully automatic and focus-free with an intuitive interface for simple measurements in thermal, visual, or MSX mode. • Compact and rugged: The FLIR Ex series cameras' low weight of 0.575 kg and the accessory belt pouch make them easy to bring along at all times. Their rugged design can withstand a 2 m drop test, and ensures reliability, even in harsh environments. • Ground breaking affordability: The FLIR Ex series cameras are the most affordable infrared cameras on the market. 	
Imaging and optical data	
IR resolution	80 × 60 pixels
Thermal sensitivity/NETD	<0.15°C (0.27°F) / <150 mK
Field of view (FOV)	45° × 34°
Minimum focus distance	0.5 m (1.6 ft.)
Spatial resolution (IFOV)	10.3 mrad
F-number	1.5
Image frequency	9 Hz
Focus	Focus free
Detector data	
Detector type	Focal plane array (FPA), uncooled microbolometer
Spectral range	7.5–13 μm
Image presentation	
Display	3.0 in. 320 × 240 color LCD
Image adjustment	Automatic adjust/lock image

P/N: 63901-0101

© 2015, FLIR Systems, Inc.

#63901-0101; r. /30746; en-US

Image presentation modes	
Image modes	Thermal MSX, Thermal, Thermal blending, Digital camera.
Multi Spectral Dynamic Imaging (MSX)	IR image with enhanced detail presentation
Measurement	
Object temperature range	-20°C to +250°C (-4°F to +482°F)
Accuracy	±2°C (±3.6°F) or ±2% of reading, for ambient temperature 10°C to 35°C (+50°F to 95°F) and object temperature above +0°C (+32°F)
Measurement analysis	
Spotmeter	Center spot
Emissivity correction	Variable from 0.1 to 1.0
Emissivity table	Emissivity table of predefined materials
Reflected apparent temperature correction	Automatic, based on input of reflected temperature
Set-up	
Color palettes	Black and white, iron and rainbow
Set-up commands	Local adaptation of units, language, date and time formats
Storage of images	
File formats	Standard JPEG, 14-bit measurement data included
Data communication interfaces	
Interfaces	USB Micro: Data transfer to and from PC and Mac device
Power system	
Battery type	Rechargeable Li ion battery
Battery voltage	3.6 V
Battery operating time	Approx. 4 hours at +25°C (+77°F) ambient temperature and typical use
Charging system	Battery is charged inside the camera or in specific charger.
Charging time	2.5 hours to 90% capacity in camera. 2 hours in charger.
Power management	Automatic shut-down
AC operation	AC adapter, 90–260 VAC input, 5 VDC output to camera
Environmental data	
Operating temperature range	-15°C to +50°C (+5°F to +122°F)
Storage temperature range	-40°C to +70°C (-40°F to +158°F)
Humidity (operating and storage)	IEC 60068-2-30/24 h 95% relative humidity
EMC	<ul style="list-style-type: none"> • WEEE 2012/19/EC • RoHs 2011/65/EC • C-Tick • EN 61000-6-3 • EN 61000-6-2 • FCC 47 CFR Part 15 Class B
Encapsulation	IP 54 (IEC 60529)

P/N: 63901-0101

© 2015, FLIR Systems, Inc.

#63901-0101; r. /30746; en-US

Environmental data	
Shock	25 g (IEC 60068-2-27)
Vibration	2 g (IEC 60068-2-6)
Drop	2 m (6.6 ft.)
Physical data	
Camera weight, incl. battery	0.575 kg (1.27 lb.)
Camera size (L x W x H)	244 x 95 x 140 mm (9.6 x 3.7 x 5.5 in.)
Color	Black and gray
Certifications	
Certification	UL, CSA, CE, PSE and CCC
Shipping information	
Packaging, type	Cardboard box
List of contents	<ul style="list-style-type: none"> • Infrared camera • Hard transport case • Battery (inside camera) • USB cable • Power supply/charger with EU, UK, US and Australian plugs • User documentation CD-ROM • Printed documentation • FLIR Tools download card
Packaging, weight	2.9 kg (6.4 lb.)
Packaging, size	385 x 165 x 315 mm (15.2 x 6.5 x 12.4 in.)
EAN-13	4743254000995
UPC-12	845188004941
Country of origin	Estonia

Supplies & accessories:

- T911093; Tool belt
- T198528; Hard transport case FLIR Ex-series
- T198530; Battery
- T198531; Battery charger incl power supply
- T198532; Car charger
- T198534; Power supply USB-micro
- T198529; Pouch FLIR Ex and ix series
- T198533; USB cable Std A <-> Micro B
- T198583; FLIR Tools+ (download card incl. license key)

Camera with built-in IR lens f=6,5 mm (45°)

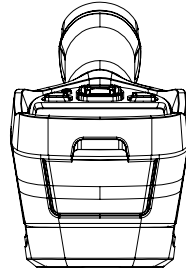
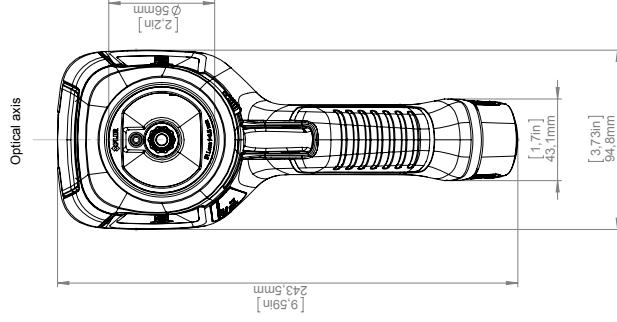
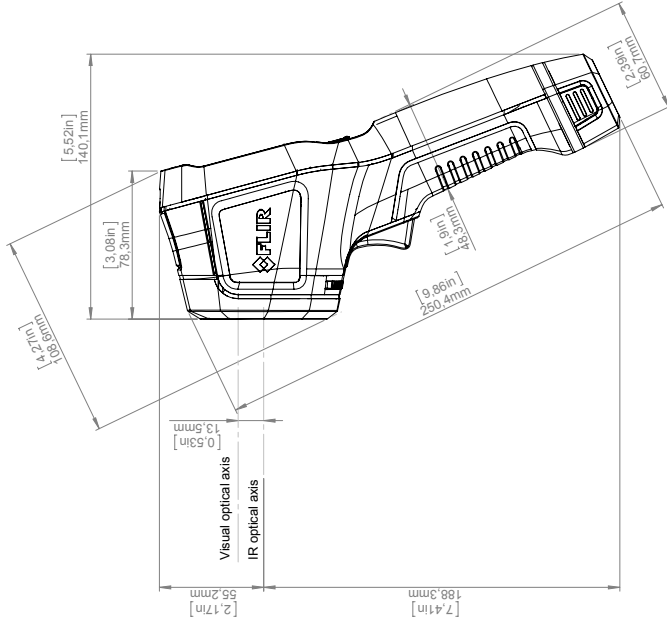
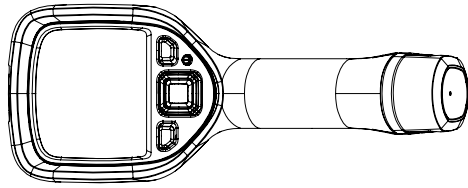
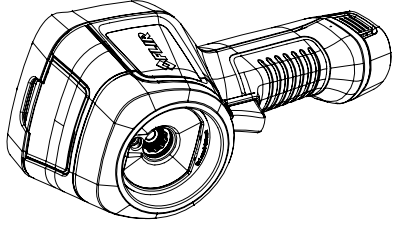
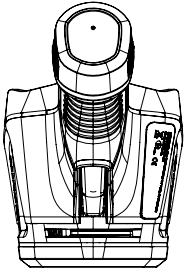

Charger and Power pack

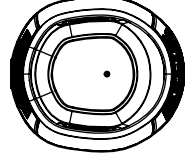
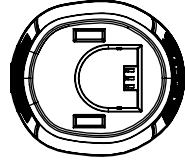
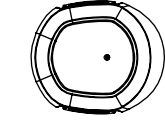
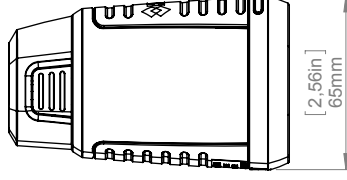
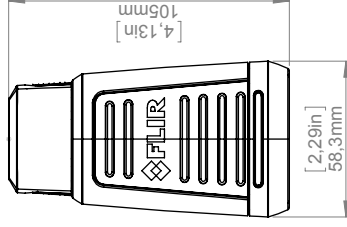
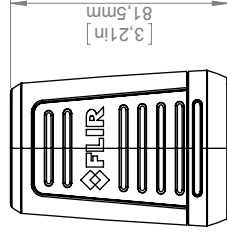
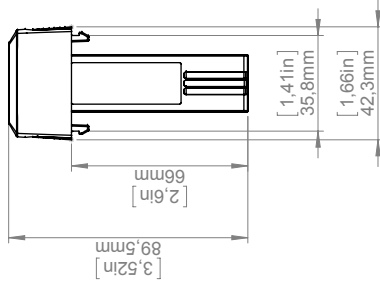
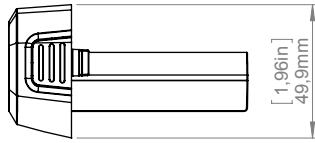
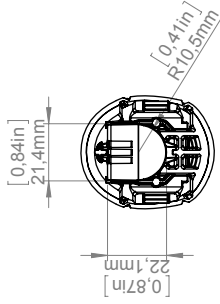
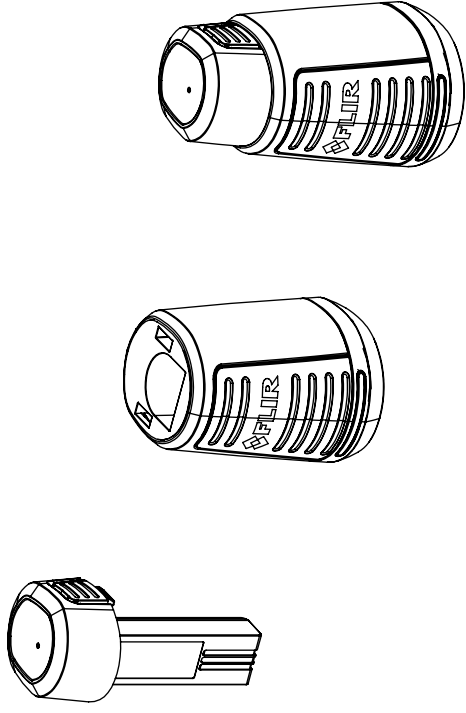

		Drawing No. T127831 Size A
Modified 2013-03-25 Denomination	Check CAHA	Drawn by R&D Thermography
Size A3 Scale 1:2		Sheet 2(2) Size A
Basic dimensions FLIR Ex		

© 2012, FLIR Systems, Inc. All rights reserved worldwide. No part of this drawing may be reproduced, stored in a retrieval system, or transmitted in any form, or by any means, electronic, mechanical, photocopying, recording, or otherwise, without written permission from FLIR Systems, Inc. Specifications subject to change without further notice. Dimensional data is based on nominal values. Products may be subject to regional market considerations. License procedures may apply. Product may be subject to US Export Regulations. Please refer to exportquestions@flir.com with any questions. Division contrary to US law is prohibited.

CE Declaration of Conformity

This is to certify that the Systems listed below have been designed and manufactured to meet the requirements, as applicable, of the following EU-Directives and corresponding harmonising standards. The systems consequently meet the requirements for the CE-mark.

Directives:

Directive 2004/108/EC; **Electromagnetic Compatibility**
Directive 2006/95/EC; **“Low voltage Directive” (Power Supply)**

Standards:

Emission: **EN 61000-6-3;** **Electro magnetic Compatibility
Generic standards - Emission**

Immunity: **EN 61000-6-2;** **Electro magnetic Compatibility;
Generic standards - Immunity**

Safety (Power Supply): **EN 60950** (or other)
**Safety of information technology
equipment**

Systems: **FLIR EX**

FLIR Systems AB
Quality Assurance



Björn Svensson
Director